

precision

cruise control

Installation instructions for

Renault Trafic III models 2014 -
Opel Vivaro models 2014 - 2018
Nissan Nv300 models 2014 -
Fiat Talento models 2016 -

Signals on CAN: Brake - Clutch - VSS



Precision Cruise Installation Guide

To make the installation easier, these instructions should be read through before the installation is started.

The installation of this system requires an adequate level of vehicle servicing skills and competence. Modern cars are equipped with electronic systems which can be damaged by inappropriate treatment.

The supplier and manufacturer of this product cannot be held responsible for damages that have occurred due to incorrect installation.

If in doubt regarding the correct installation of this product, it is advisable to seek the services of a professional installer or automotive electrician.

Check that all the parts are included in the kit.

1 pc	Control Module.
1 pc	Control Stalk.
1 pc	14 way Accelerator connection cable.
1 pc	2 way CAN Bus connection cable.
1 pc	Operation guide.

For vehicles that do not feature CAN Bus, an analogue wiring harness is supplied as a substitute to the CAN Bus connection cable.

Some systems also include a Clutch Switch and / or a Clutch switch connection cable. Many systems do not require these parts, please refer to the installation guide to determine if this installation requires any additional part(s).

Installation advice

- Always disconnect the negative cable from the battery before installing but check prior to doing so that audio codes and any vehicle specific battery re-connection procedures are understood.

- Identify a suitable location to install the control unit and control stalk.

Note that all wire connections detailed in the installation guide are viewed from the wire side of the connector.

- Use a multimeter or suitable LED test probe to confirm powering points.

All joined wire connections must be soldered.

When The Installation Is Complete

Before Road Testing the vehicle, run through the diagnostic procedure detailed in the Diagnostics & Trouble Shooting Guide. Performing this procedure will confirm that the Precision Cruise is reading the correct signals from the vehicle.

- Always take the vehicle for a comprehensive test drive prior to refitting trims and panels to ensure that all systems and vehicle features are working to the same standard as prior to the installation.

After confirming the normal operation of the vehicle, thoroughly test the Precision Cruise operation as detailed in the Operation Guide.

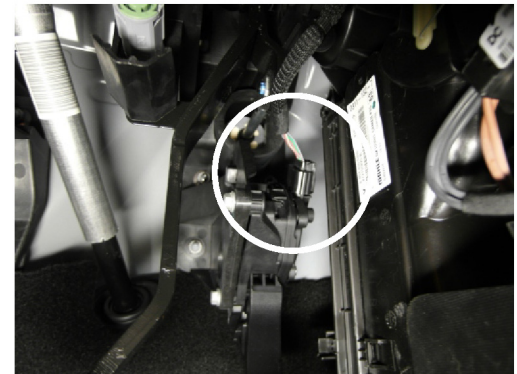
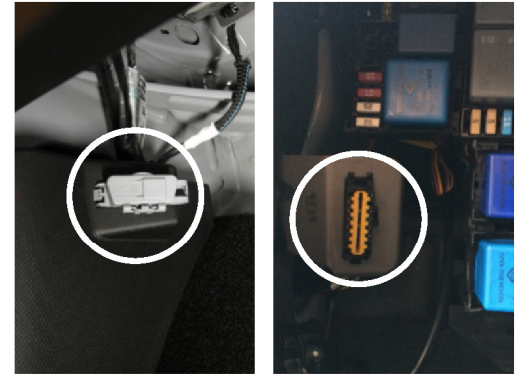
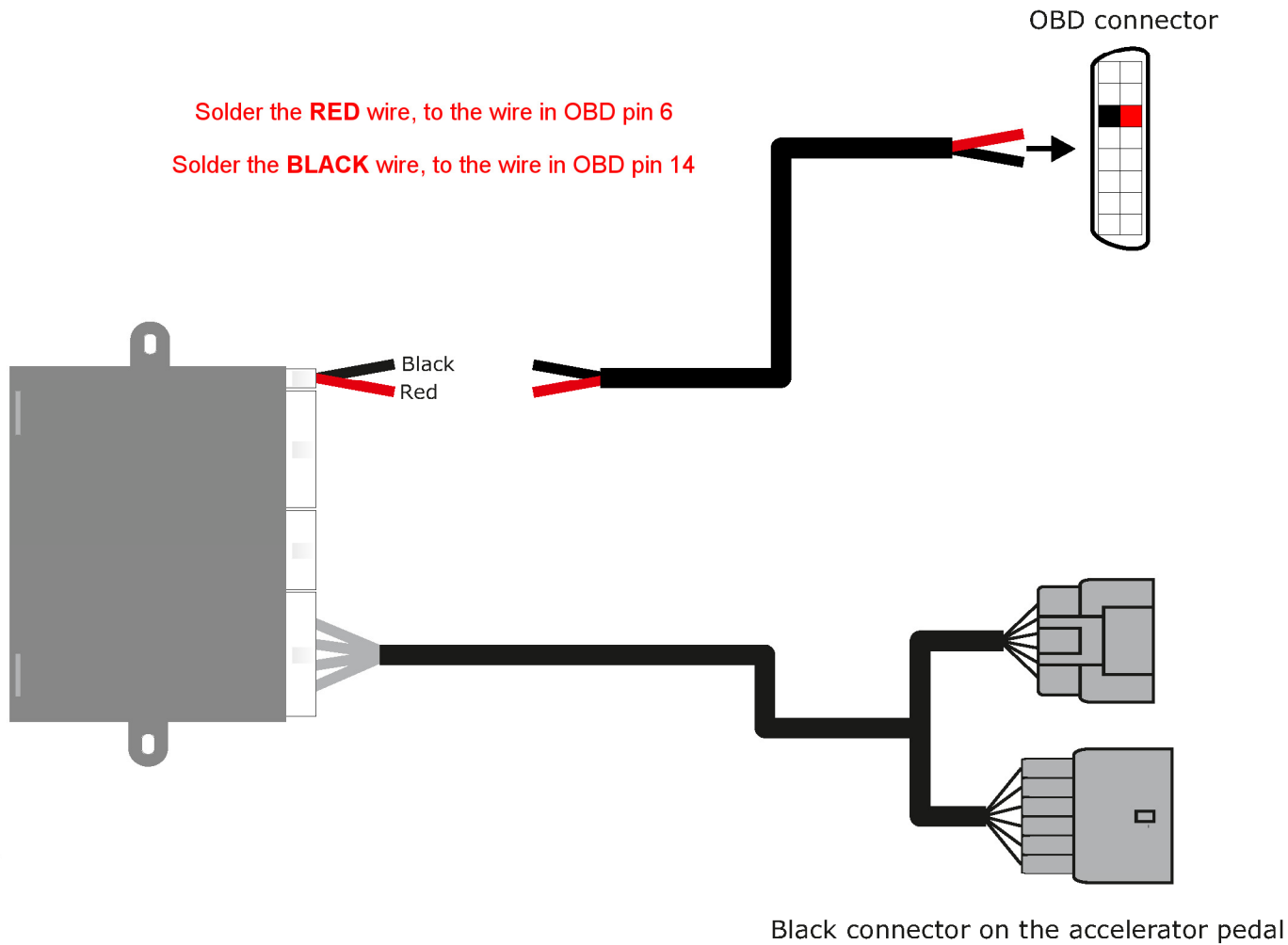

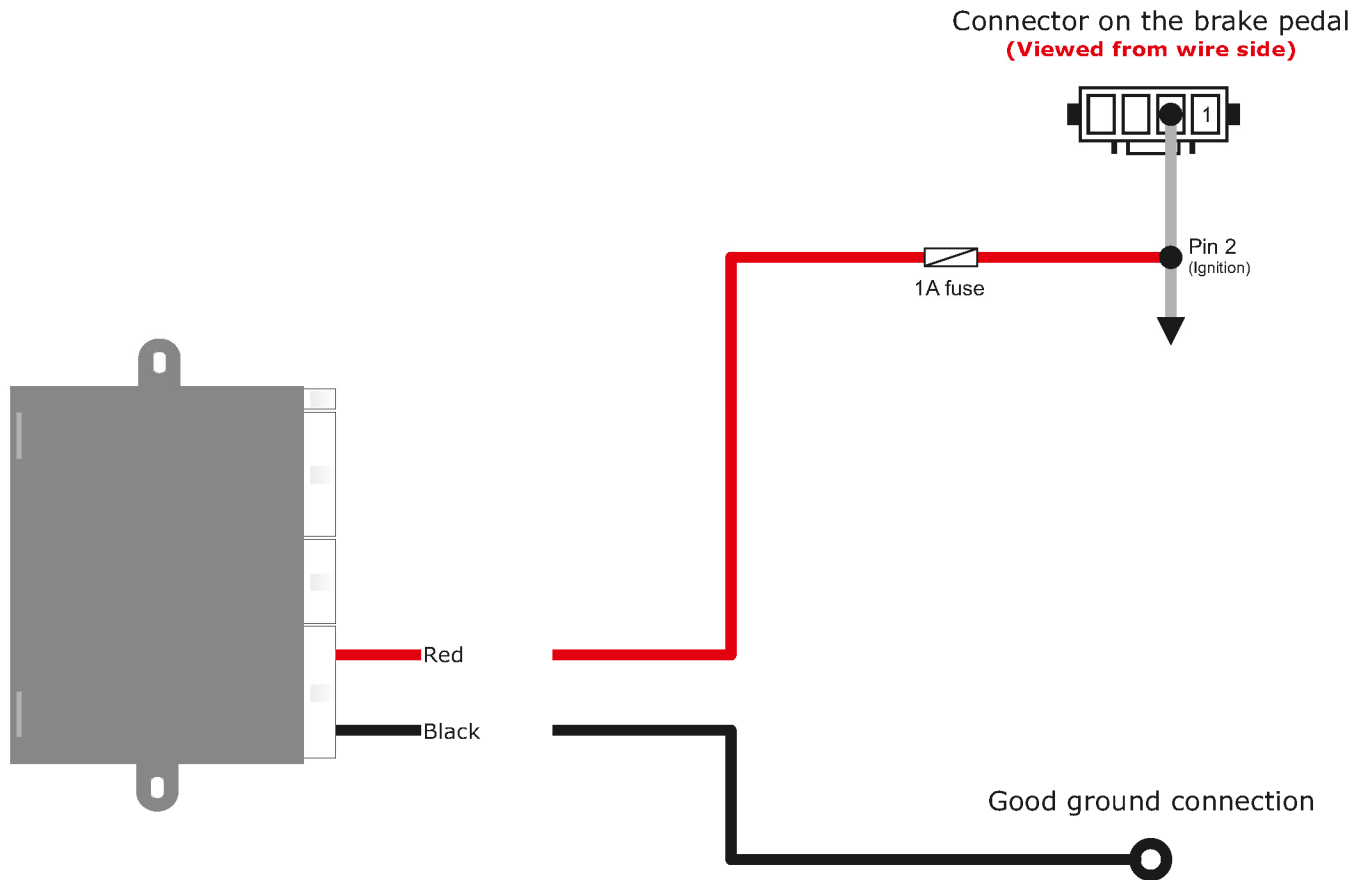

Precision Cruise Diagnostics & Trouble Shooting Guide.

To Enter Diagnostic mode:

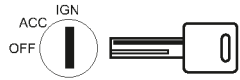

Turn the vehicle Ignition on.

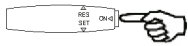

Within 2 seconds, press and hold the ON button



Wait until the Stalk LED illuminates Red



Release ON function



Within 5 seconds

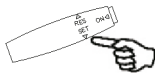

Press the SET button



The Stalk LED illuminates Orange



Release the SET button



Within 5 seconds

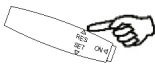

Press the RES button



The Stalk LED will flash Red, Green & Orange

Five individual diagnostic tests and 1 mode setting are available:

Test 1 - Foot Brake Operation. Press the RES button once to select this test. The Stalk LED will flash one time. If the Foot Brake is detected via CAN Bus (i.e. no direct wired connections have been made to the brake pedal switch). The Stalk LED lights up Red and changes to Green when the brake pedal is depressed.

Analog installation: (Direct wiring has been made to the brake pedal switch).
If both brake pedal switch wires are installed correctly, the Stalk LED will light up Green and change to Orange when the brake pedal is pressed.
If Connection to the 12V side of the brake pedal switch is defective = Stalk LED lights up red.
If Connection to the switched side of the brake pedal switch is defective = Stalk LED lights up orange.
If Both connections to the brake pedal switch are defective = Stalk LED flashes all 3 colours.

Test 2 - Clutch Operation. Press the RES button once to advance to this test. The Stalk LED will flash two times. If the Clutch is detected via CAN Bus (i.e. no direct wired connections have been made to the clutch pedal switch). The Stalk LED lights up Red and changes to Green when the Clutch pedal is depressed.

Analog installation: (Direct wiring has been made to the brake pedal switch).
If clutch wires are installed correctly, the Stalk LED lights up Green and changes to Red when the Clutch Pedal is depressed.
If the clutch connection is defective, the Stalk LED lights up Red.

Test 3 - Accelerator (Engine Off). Press the RES button once to advance to this test. The Stalk LED will flash three times. The Stalk LED will flash slowly, alternating between Red & Green. Depressing the accelerator pedal will increase the speed of the flashing.

Test 4 - Vehicle Speed. Press the RES button once to advance to this test. The Stalk LED will flash four times. If vehicle speed is detected via CAN Bus (i.e. the Purple wire connection has not been made): The Stalk LED will flash green if vehicle speed information is being received.

Analog installation: (The Purple wire is connected).
The Stalk LED will flash green when the vehicle is moved.

Test 5 - RPM Signal. Press the RES button once to advance to this test. The Stalk LED will flash five times. If RPM is detected via CAN Bus (i.e. the Yellow-Red wire connection has not been made): The Stalk LED will flash green if RPM information is being received.

Analog installation: (The Yellow-Red wire is connected).
The Stalk LED will flash green when RPM is raised.

Mode 6 - Transmission Type. Press the RES button once to advance to this test. The Stalk LED will flash six times. **Transmission Type should only be changed if instructed by Technical Support.**

To select Automatic Transmission mode:

Depress and hold the brake pedal. Press the SET button, the Stalk LED illuminates Red. Press the SET button, the Stalk LED turns Orange, release the brake pedal. Automatic Transmission mode is now selected. In this mode, Precision Cruise will not respond to CAN based Clutch activity but will respond to direct wired (analogue) activity.

To select Manual Transmission mode:

Depress and hold the brake pedal. Press the SET button, the Stalk LED illuminates Red. Press the SET button, the Stalk LED turns Orange, release the brake pedal. Manual Transmission mode is now selected. In this mode, Precision Cruise will respond to CAN and direct wired (analogue) based Clutch activity.

Please Note:

Test 2 is not applicable to vehicles with Automatic Transmission.

Test 5 is not essential to many vehicles. For vehicles with Manual Transmission, please confirm during road testing that depressing the Clutch pedal deactivates the cruise control when it is engaged.

Depressing the brake pedal on all vehicles should always cause the cruise control to deactivate when it is engaged.

1. Find a suitable position for the switch on the left side of the covering around the steering column.
2. Mark the position and drill a 10mm hole. Make sure there is room for the switch and wires inside the steering column cover.
3. Use the enclosed fittings so the switch is angled to match the drivers position.
4. The switch head can be rotated as desired, and locked with the supplied clip retainer.
Be sure to insert the clip retainer correctly, clicked all the way in so that it is level with the surface.
5. Route the cable back to the Precision Cruise module and insert the wires in to the connectors, see the next page.

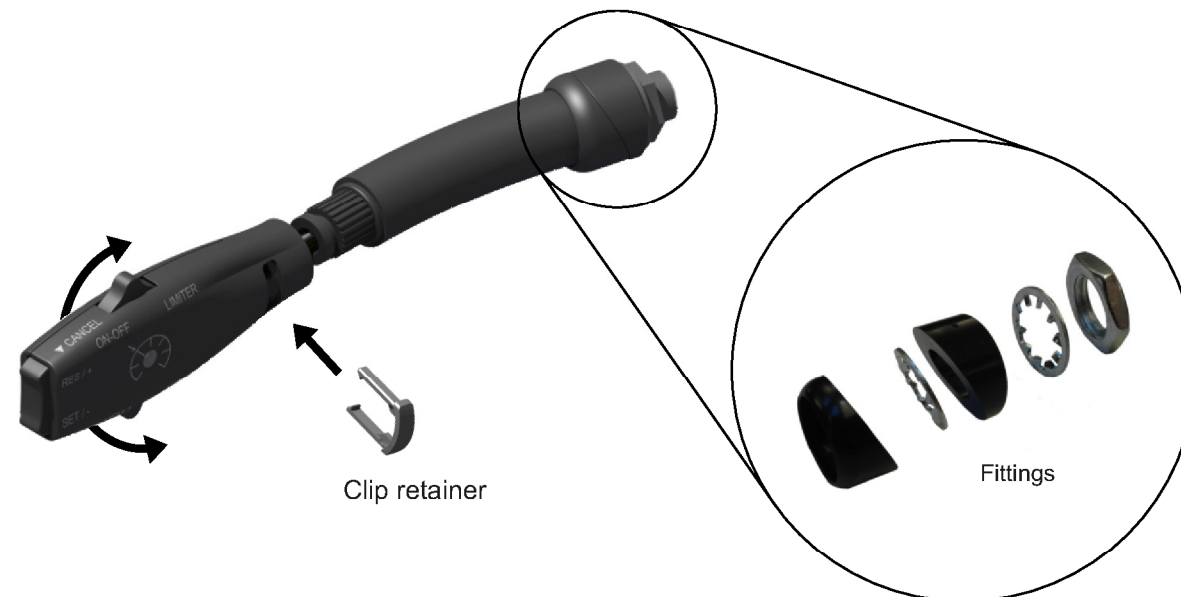

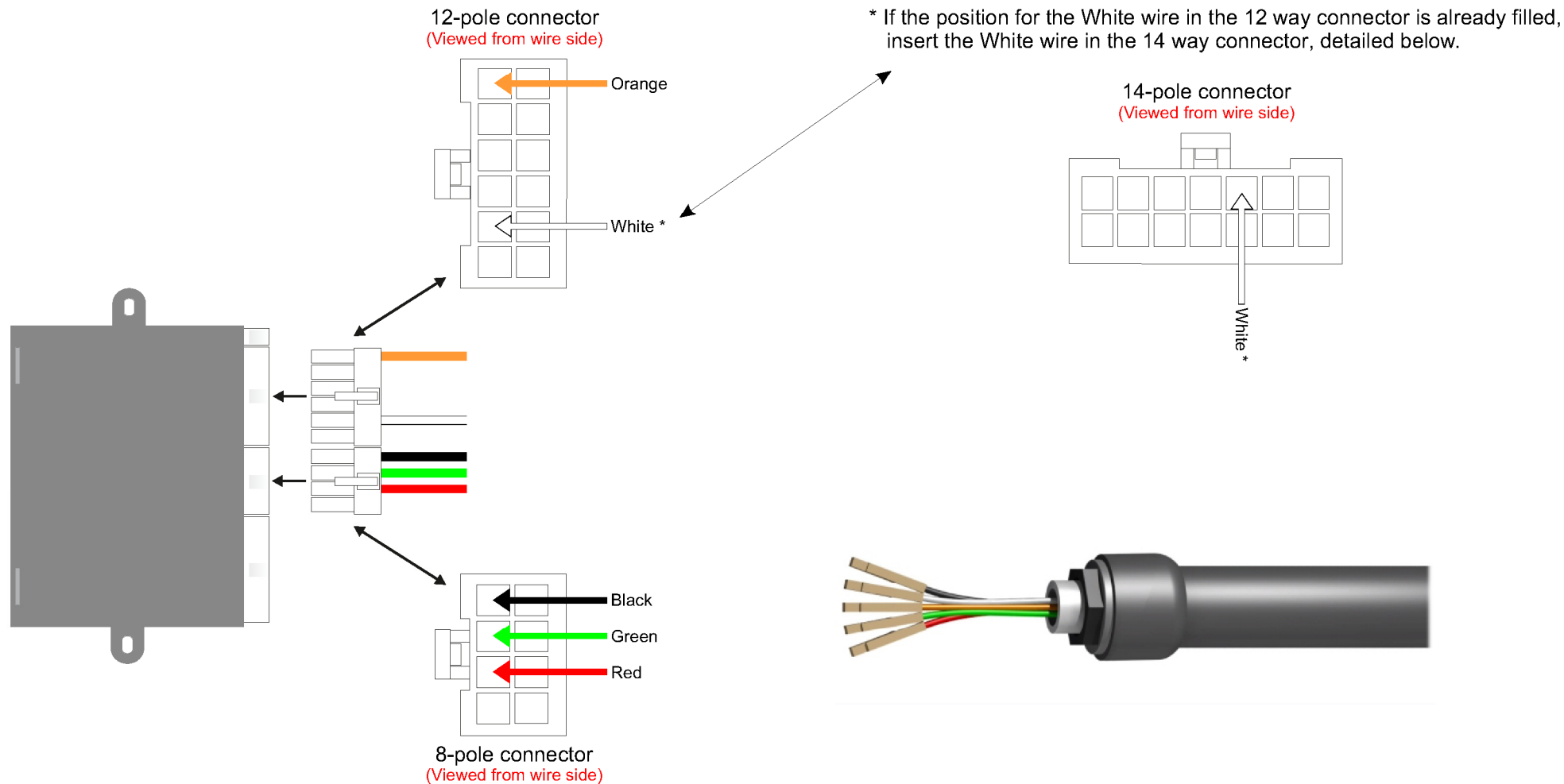

The Precision Cruise system can regulate the selected vehicle road speed, respective of the performance characteristics of the vehicle.

Memory functions can be programmed for 2 different commonly used cruise speeds.

The Limiter function is an optional, driver selectable speed limiting feature. This can be set in place of selecting a cruise function.

Only use Precision Cruise in suitable driving conditions. The system should not be used when poor road surfaces are apparent or when bad weather impedes visibility or vehicle control.

On/Off: Touch the **ON-OFF** button to the left to turn the system ON and Off. The LED illuminates Green when the system is ready to use. Always turn the system off when not in use. Precision Cruise will automatically turn off when the ignition is switched off. The LED will be switched off.

Set: Drive at a constant speed and briefly touch the **SET/-** key. Remove your foot from the accelerator pedal as the cruise takes control of the accelerator function. The LED illuminates Orange to confirm cruise mode is engaged.

Disconnection: To de-activate the cruise, press the **CANCEL** key on the back of the switch or press the brake or the clutch pedal. Precision Cruise will remember the last selected speed. LED illuminates Green to confirm the cruise system is ready for use.

Resume: Touch the **RES/+** key and the vehicle will return to the speed last selected, unless the ignition has been switched off, or **ON-OFF** has been selected in the meantime. The LED illuminates Orange to confirm the cruise function is engaged.

Decelerate: Touch and hold the **SET/-** key for more than one second and the cruise will gradually decrease speed until **SET/-** is released*. The speed when **SET/-** is released will then be the new speed selected. A quick touch on **SET/- key** will decrease speed by approximately 1 km/h per touch.

Accelerate: Touch and hold the **RES/+** key for more than one second and the cruise will gradually increase speed until the **RES/+** key is released. The speed when **RES/+** is released will then be the new speed selected. A quick touch on the **RES/+** key will increase speed by approximately 1 km/h per touch.

MEM-1 MEM-2: Drive at a constant speed and touch the **MEM** button that you wish to program for about 3 seconds. Remove your foot from the accelerator pedal as the cruise takes over control of the accelerator, the cruise LED illuminates Orange. The speed is now programmed into memory. Use the same procedure for the other button if and when desired. The speed will be stored regardless of ignition off or vehicle battery disconnection. To revise either **MEM** stored speed, repeat the above procedure.

MEM functions can not be programmed when Precision Cruise is in operation and the cruise function is already engaged. In this case, dis-engage the cruise function first and then follow the procedure above to program a new memory speed.

LIMITER: Drive at a constant speed and briefly touch the **LIMITER** button to the right. The LED illuminates Red. The selected speed can not be exceeded. To cancel the limiter, briefly touch the **LIMITER** button again or fully depress the accelerator pedal for approximately 2 seconds.

